

Gresley #7,8,9

Statistics

Area: 868 sq ft
 1 Floor
 3 Bedrooms
 1 Bathroom

Ground Floor

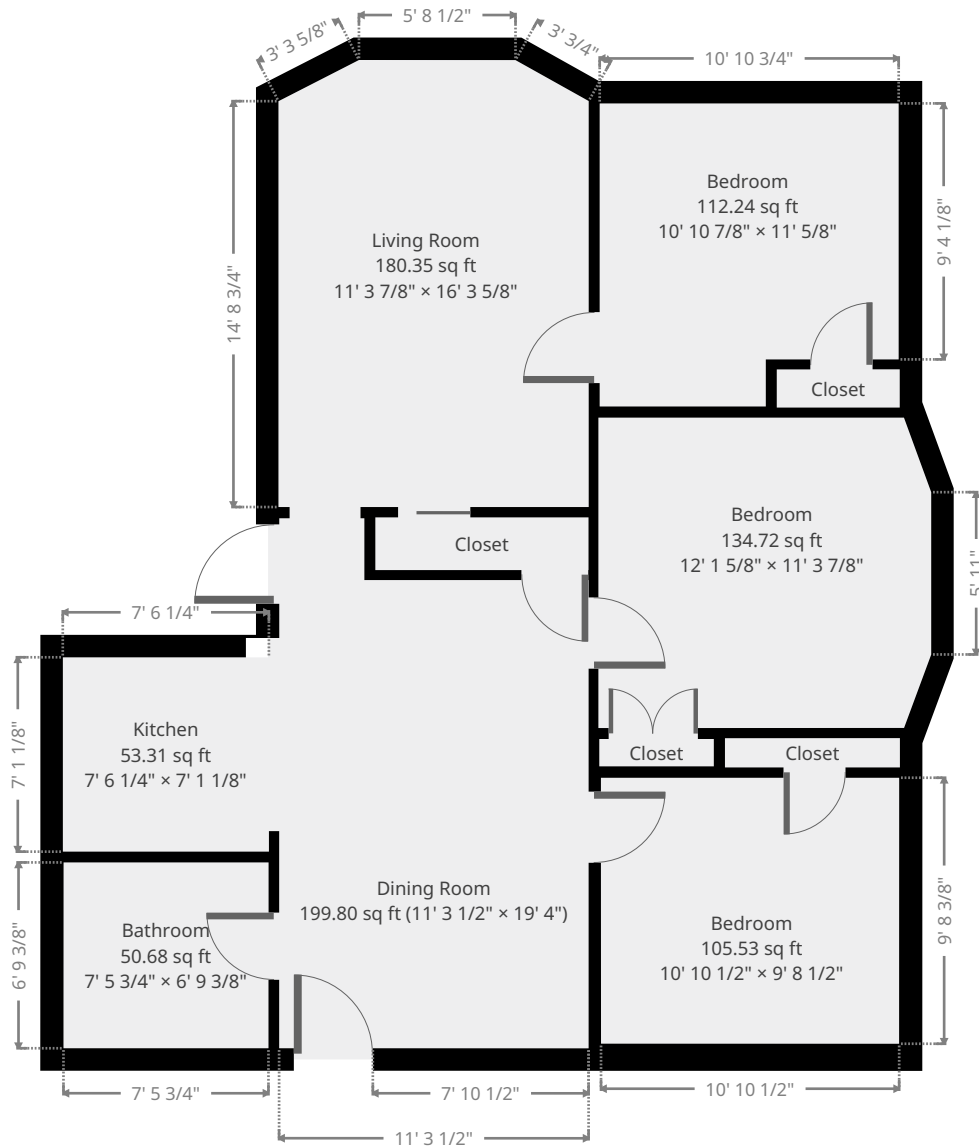

THIS FLOORPLAN IS PROVIDED WITHOUT WARRANTY OF ANY KIND. SENSOPIA DISCLAIMS ANY WARRANTY INCLUDING, WITHOUT LIMITATION, SATISFACTORY QUALITY OR ACCURACY OF DIMENSIONS.

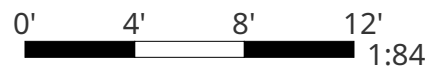

Gresley #7,8,9

Dining Room

Width: 11' 3 1/2"
 Length: 19' 4"
 Area: 199.80 sq ft
 Perimeter: 61' 2 7/8"

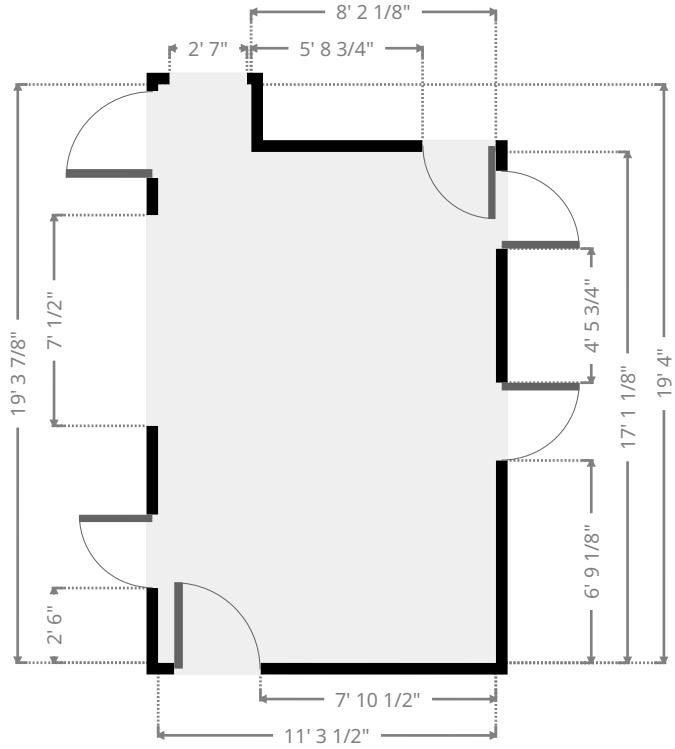
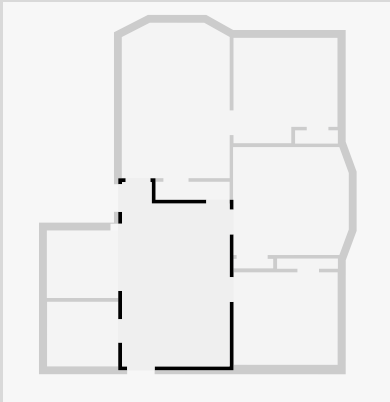

Bathroom

Width: 6' 9 3/8"
 Length: 7' 5 3/4"
 Area: 50.68 sq ft
 Perimeter: 28' 6 1/8"

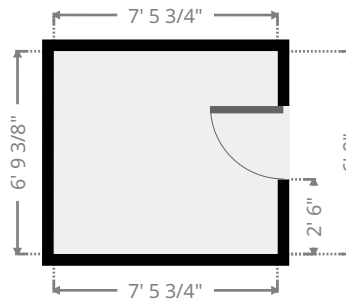
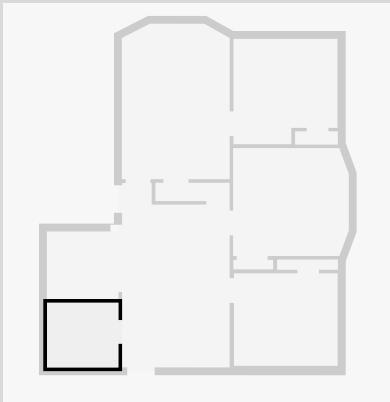

THIS FLOORPLAN IS PROVIDED WITHOUT WARRANTY OF ANY KIND. SENSOPIA DISCLAIMS ANY WARRANTY INCLUDING, WITHOUT LIMITATION, SATISFACTORY QUALITY OR ACCURACY OF DIMENSIONS.

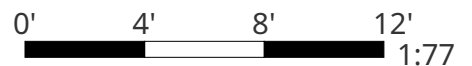

Gresley #7,8,9

Kitchen

Width: 7' 1 1/8"
 Length: 7' 6 1/4"
 Area: 53.31 sq ft
 Perimeter: 29' 2 5/8"

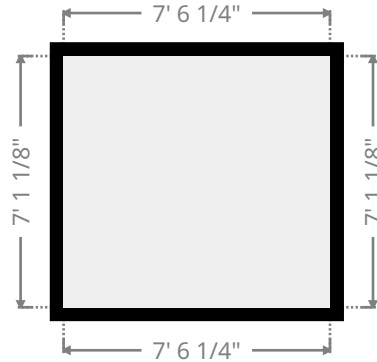
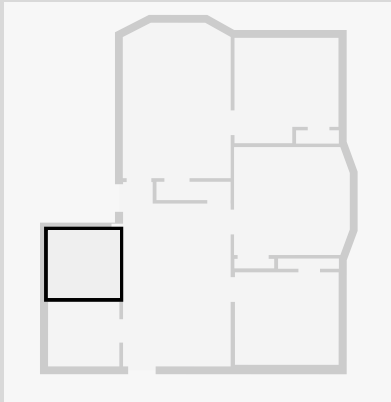

Living Room

Width: 11' 3 7/8"
 Length: 16' 3 5/8"
 Area: 180.35 sq ft
 Perimeter: 53'

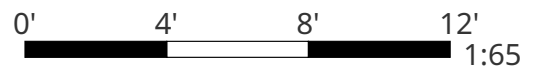
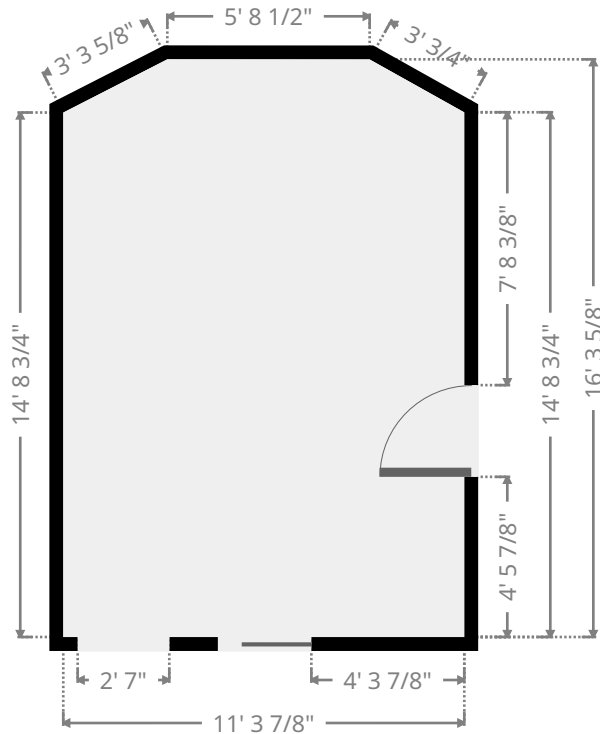

THIS FLOORPLAN IS PROVIDED WITHOUT WARRANTY OF ANY KIND. SENSOPIA DISCLAIMS ANY WARRANTY INCLUDING, WITHOUT LIMITATION, SATISFACTORY QUALITY OR ACCURACY OF DIMENSIONS.

Gresley #7,8,9

Closet

Width: 1' 11 1/8"
 Length: 7' 9 3/8"
 Area: 14.95 sq ft
 Perimeter: 19' 4 7/8"

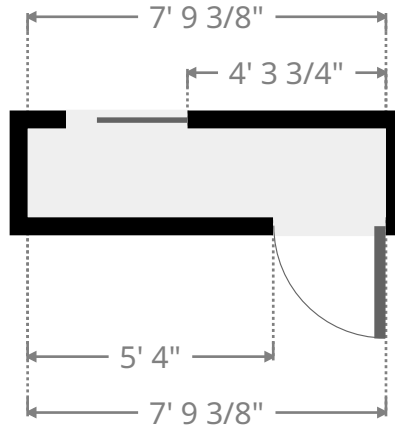

Bedroom

Width: 10' 10 7/8"
 Length: 11' 5/8"
 Area: 112.24 sq ft
 Perimeter: 43' 11"

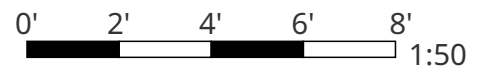
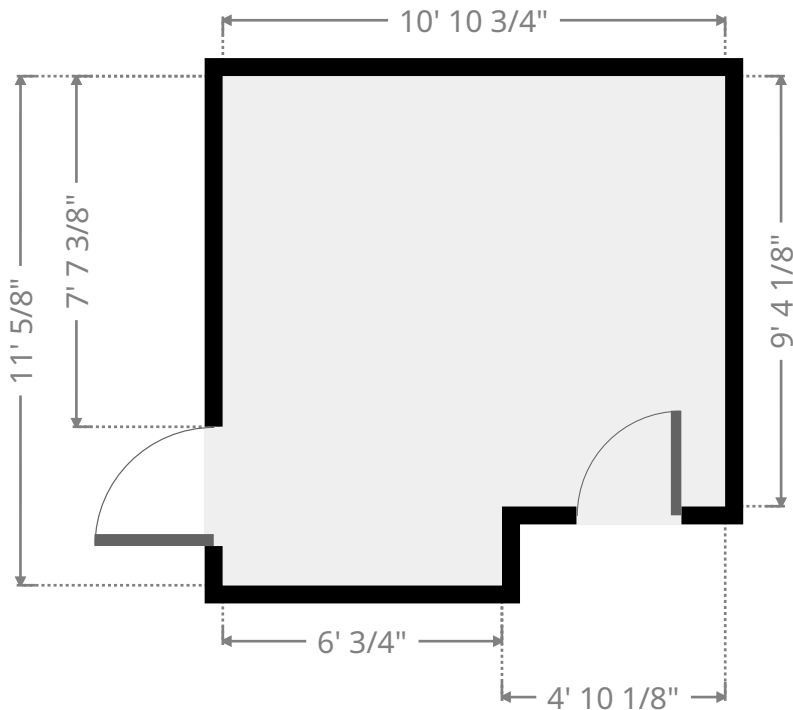
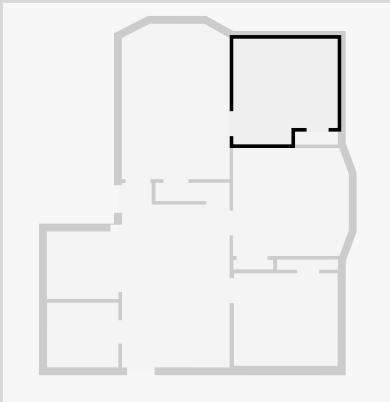

THIS FLOORPLAN IS PROVIDED WITHOUT WARRANTY OF ANY KIND. SENSOPIA DISCLAIMS ANY WARRANTY INCLUDING, WITHOUT LIMITATION, SATISFACTORY QUALITY OR ACCURACY OF DIMENSIONS.

Gresley #7,8,9

Closet

Width: 1' 4 3/4"
 Length: 4' 5 3/4"
 Area: 6.24 sq ft
 Perimeter: 11' 9"

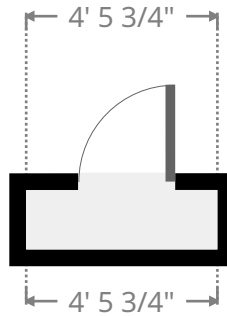

Bedroom

Width: 11' 3 7/8"
 Length: 12' 1 5/8"
 Area: 134.72 sq ft
 Perimeter: 45' 3 3/8"

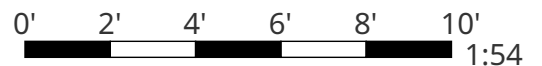
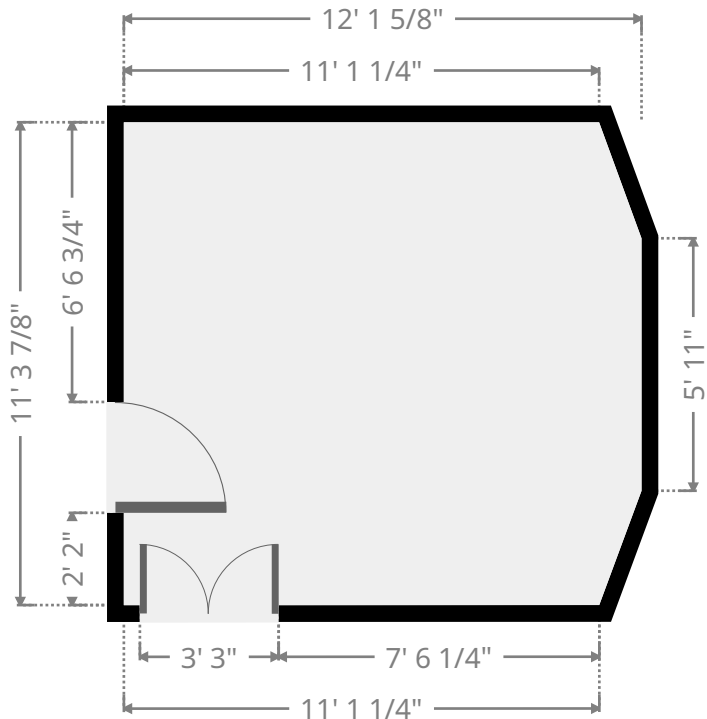
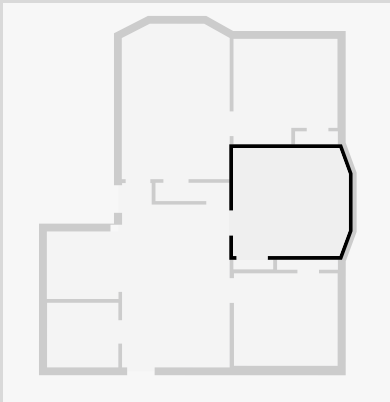

THIS FLOORPLAN IS PROVIDED WITHOUT WARRANTY OF ANY KIND. SENSOPIA DISCLAIMS ANY WARRANTY INCLUDING, WITHOUT LIMITATION, SATISFACTORY QUALITY OR ACCURACY OF DIMENSIONS.

Gresley #7,8,9

Closet

Width: 1'
 Length: 4' 2 1/8"
 Area: 4.17 sq ft
 Perimeter: 10' 4 1/4"

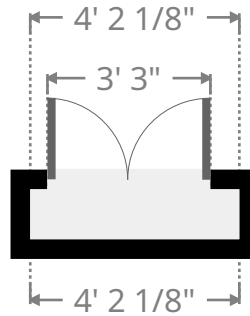
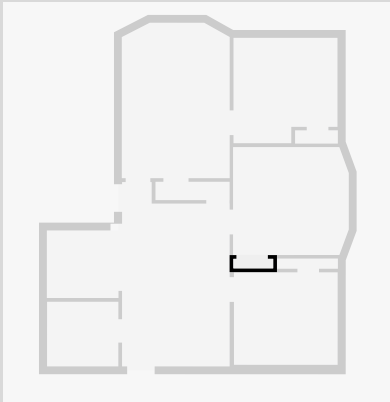

Bedroom

Width: 9' 8 1/2"
 Length: 10' 10 1/2"
 Area: 105.53 sq ft
 Perimeter: 41' 1 7/8"

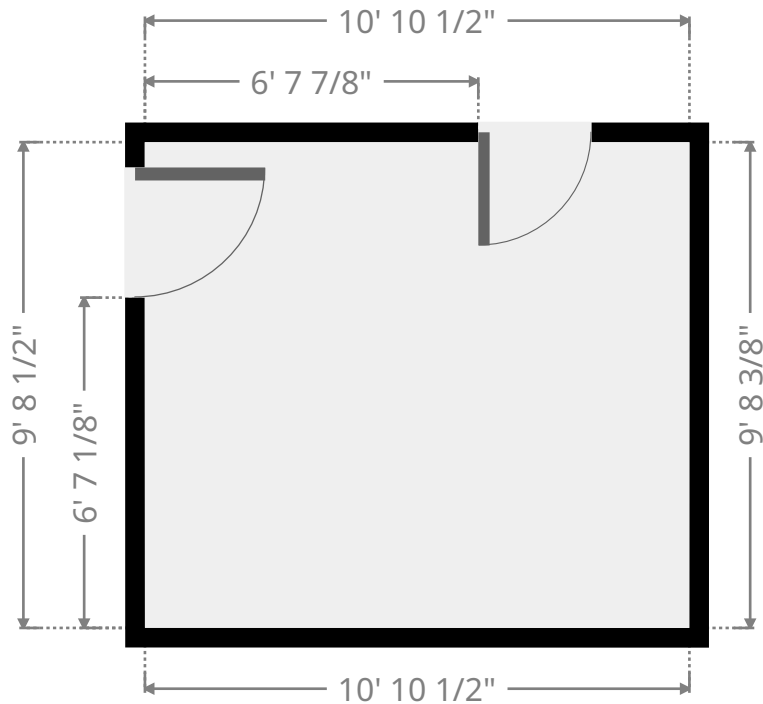
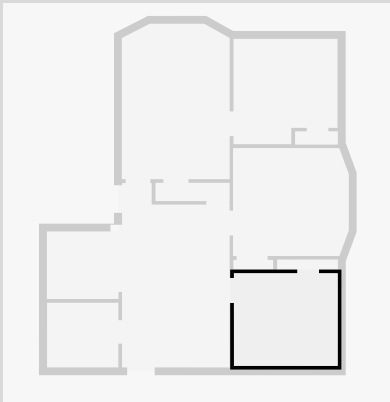

THIS FLOORPLAN IS PROVIDED WITHOUT WARRANTY OF ANY KIND. SENSOPIA DISCLAIMS ANY WARRANTY INCLUDING, WITHOUT LIMITATION, SATISFACTORY QUALITY OR ACCURACY OF DIMENSIONS.



Gresley #7,8,9

Closet

Width: 1' 3/4"
Length: 6' 4 5/8"
Area: 6.81 sq ft
Perimeter: 14' 10 7/8"

