

Gresley 25 and 27

Statistics

Area: 876 sq ft

1 Floor

2 Bedrooms

1 Bathroom

Ground Floor



THIS FLOORPLAN IS PROVIDED WITHOUT WARRANTY OF ANY KIND. SENSOPIA DISCLAIMS ANY WARRANTY INCLUDING, WITHOUT LIMITATION, SATISFACTORY QUALITY OR ACCURACY OF DIMENSIONS.

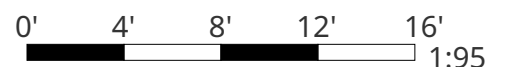

Gresley 25 and 27

Bedroom

Width: 10' 9 3/8"
 Length: 11' 3/4"
 Area: 112.91 sq ft
 Perimeter: 43' 8 1/4"

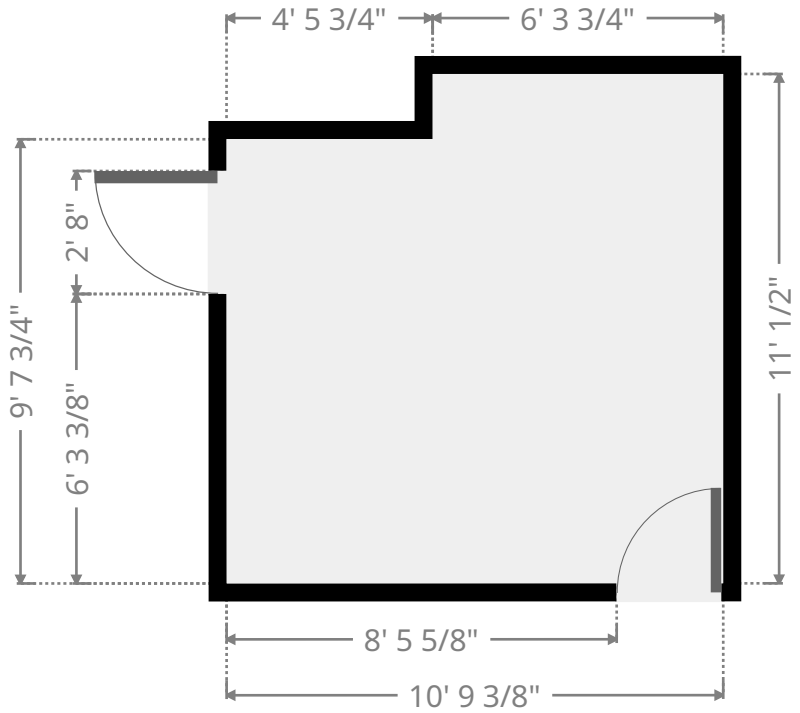
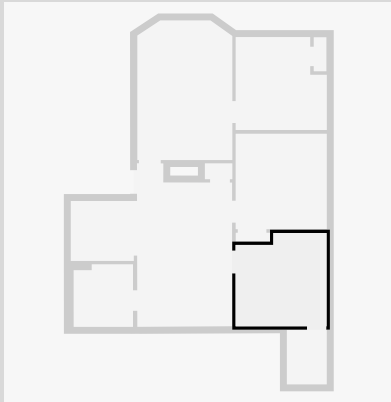

Closet

Width: 4' 8 3/4"
 Length: 6' 5 5/8"
 Area: 30.60 sq ft
 Perimeter: 22' 4 3/4"

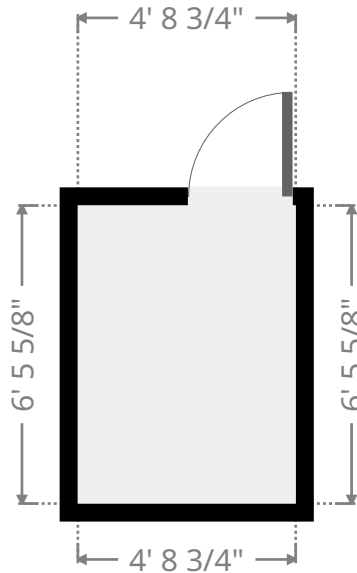
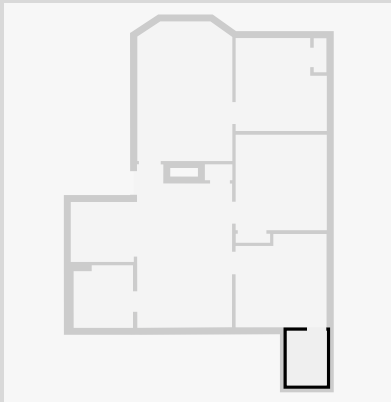

THIS FLOORPLAN IS PROVIDED WITHOUT WARRANTY OF ANY KIND. SENSOPIA DISCLAIMS ANY WARRANTY INCLUDING, WITHOUT LIMITATION, SATISFACTORY QUALITY OR ACCURACY OF DIMENSIONS.

Gresley 25 and 27

Dining Room

Width: 11' 4 5/8"
 Length: 19' 4 5/8"
 Area: 199.14 sq ft
 Perimeter: 61' 2 1/4"

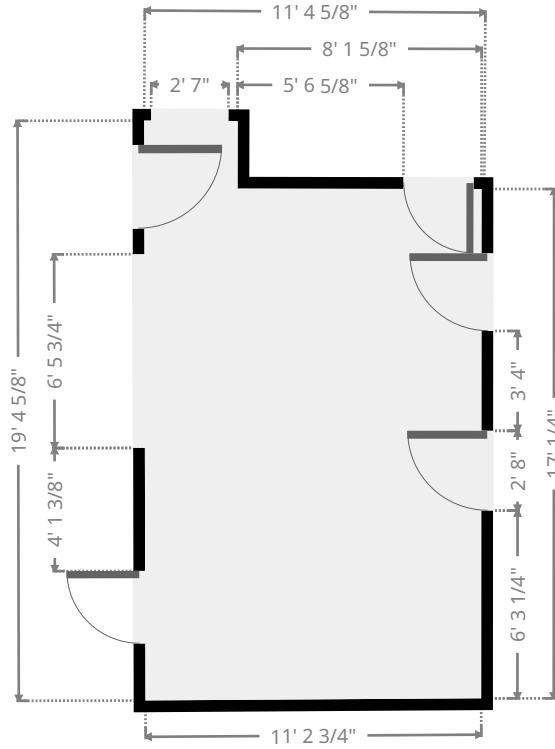
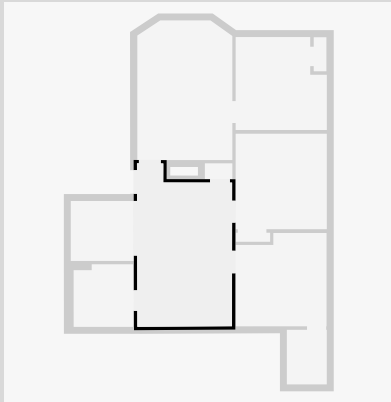

Closet

Width: 1' 10 5/8"
 Length: 3' 3 1/8"
 Area: 6.14 sq ft
 Perimeter: 10' 3 3/8"

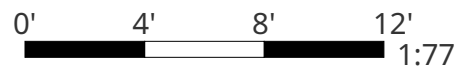
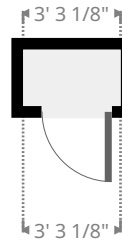
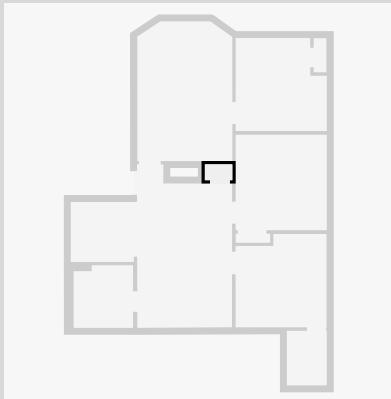

THIS FLOORPLAN IS PROVIDED WITHOUT WARRANTY OF ANY KIND. SENSOPIA DISCLAIMS ANY WARRANTY INCLUDING, WITHOUT LIMITATION, SATISFACTORY QUALITY OR ACCURACY OF DIMENSIONS.

Gresley 25 and 27

Living Room

Width: 11' 3 1/8"
 Length: 16' 6 5/8"
 Area: 181.49 sq ft
 Perimeter: 53' 1 1/4"

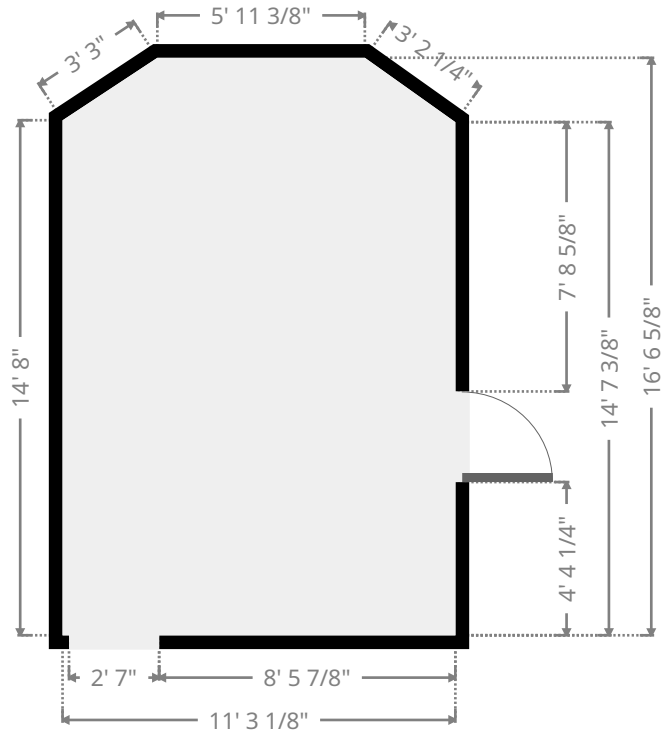
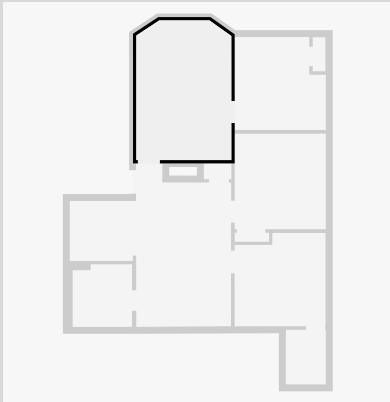

Bedroom

Width: 10' 9 3/4"
 Length: 11' 1/4"
 Area: 110.26 sq ft
 Perimeter: 43' 7 3/4"

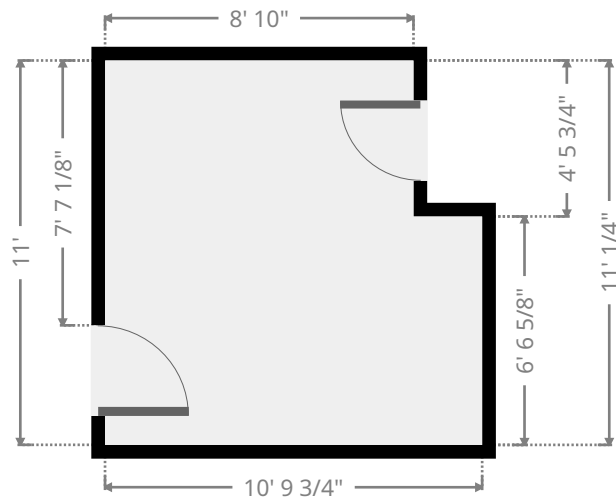
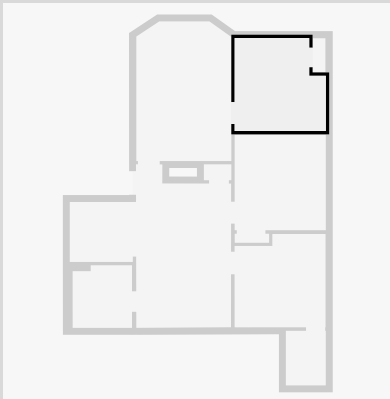

THIS FLOORPLAN IS PROVIDED WITHOUT WARRANTY OF ANY KIND. SENSOPIA DISCLAIMS ANY WARRANTY INCLUDING, WITHOUT LIMITATION, SATISFACTORY QUALITY OR ACCURACY OF DIMENSIONS.

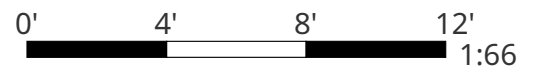

Gresley 25 and 27

Closet

Width: 1' 6"
 Length: 4' 3/8"
 Area: 6.05 sq ft
 Perimeter: 11' 3/4"

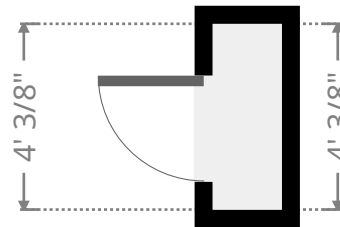
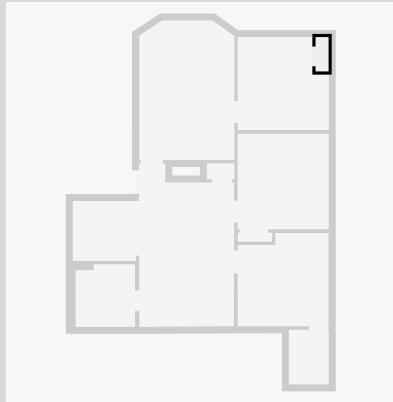

Living Room

Width: 10' 9 5/8"
 Length: 11' 3 7/8"
 Area: 122.28 sq ft
 Perimeter: 44' 2 7/8"

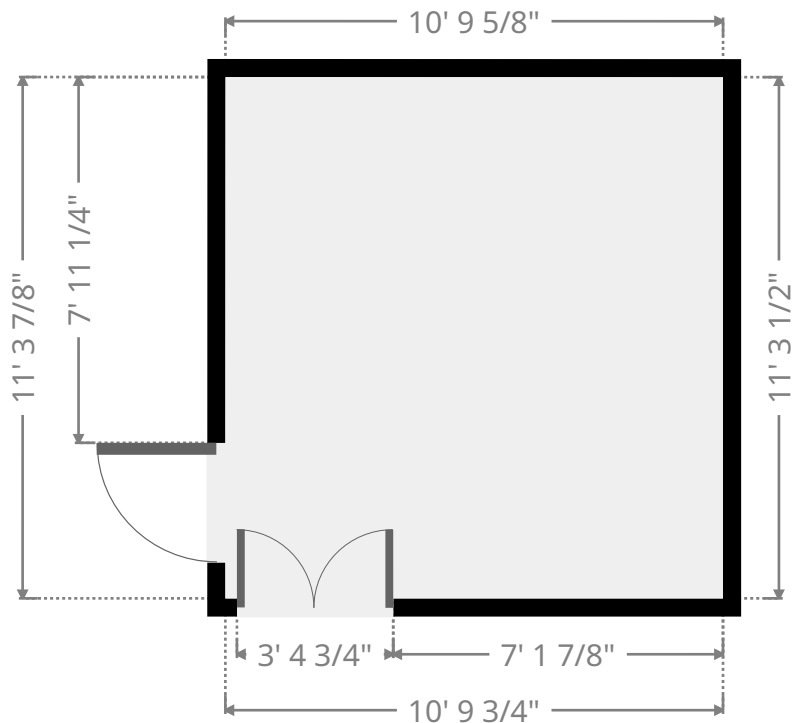
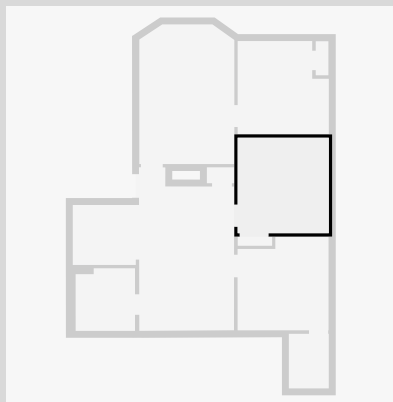

THIS FLOORPLAN IS PROVIDED WITHOUT WARRANTY OF ANY KIND. SENSOPIA DISCLAIMS ANY WARRANTY INCLUDING, WITHOUT LIMITATION, SATISFACTORY QUALITY OR ACCURACY OF DIMENSIONS.

Gresley 25 and 27

Closet

Width: 1' 7/8"
 Length: 4' 7/8"
 Area: 4.37 sq ft
 Perimeter: 10' 3 1/2"

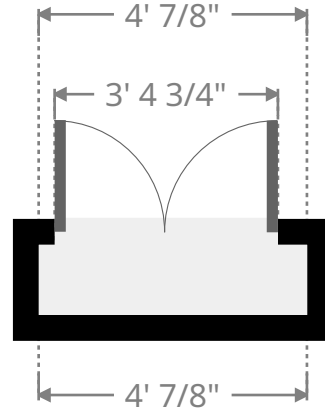
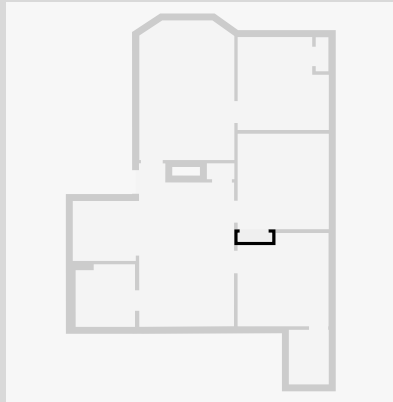

Kitchen

Width: 7' 1 3/8"
 Length: 7' 5 5/8"
 Area: 53.11 sq ft
 Perimeter: 29' 1 7/8"

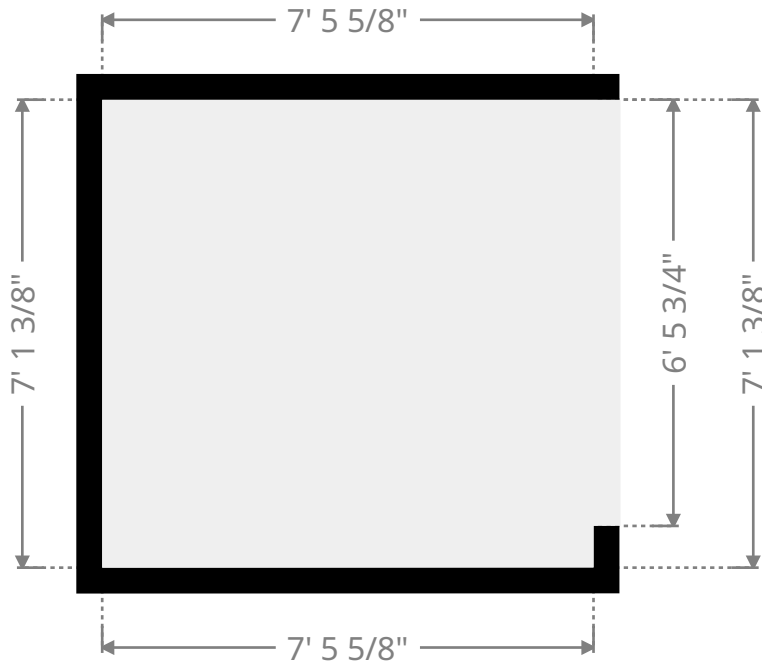
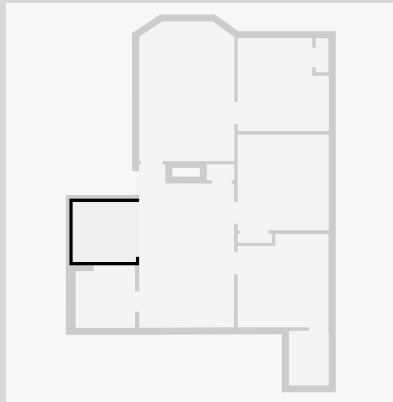

THIS FLOORPLAN IS PROVIDED WITHOUT WARRANTY OF ANY KIND. SENSOPIA DISCLAIMS ANY WARRANTY INCLUDING, WITHOUT LIMITATION, SATISFACTORY QUALITY OR ACCURACY OF DIMENSIONS.

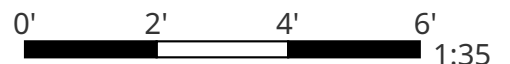

Gresley 25 and 27

Bathroom

Width: 7' 1/2"
Length: 7' 5"
Area: 50.69 sq ft
Perimeter: 28' 10 7/8"

