

# Gresley #20 and 21

## Statistics

Area: 863 sq ft  
 1 Floor  
 2 Bedrooms  
 1 Bathroom

## Ground Floor

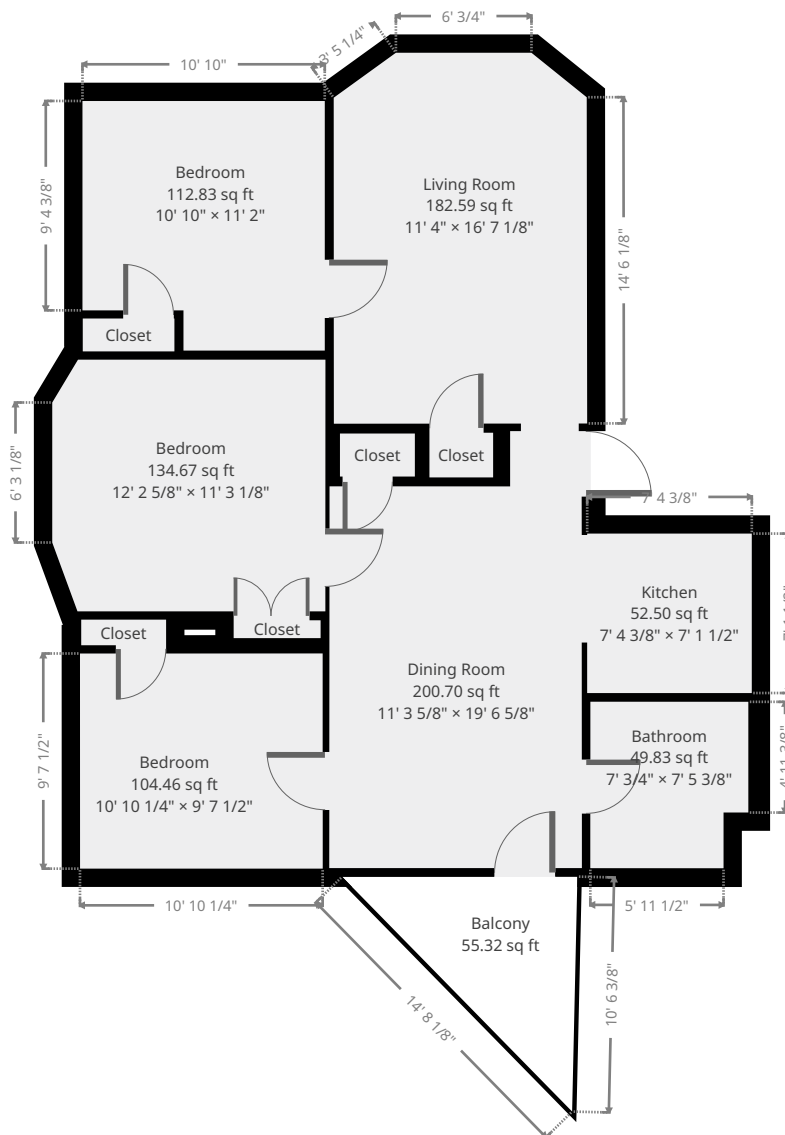

THIS FLOORPLAN IS PROVIDED WITHOUT WARRANTY OF ANY KIND. SENSOPIA DISCLAIMS ANY WARRANTY INCLUDING, WITHOUT LIMITATION, SATISFACTORY QUALITY OR ACCURACY OF DIMENSIONS.



# Gresley #20 and 21

## Dining Room

Width: 11' 3 5/8"  
 Length: 19' 6 5/8"  
 Area: 200.70 sq ft  
 Perimeter: 61' 8 1/8"

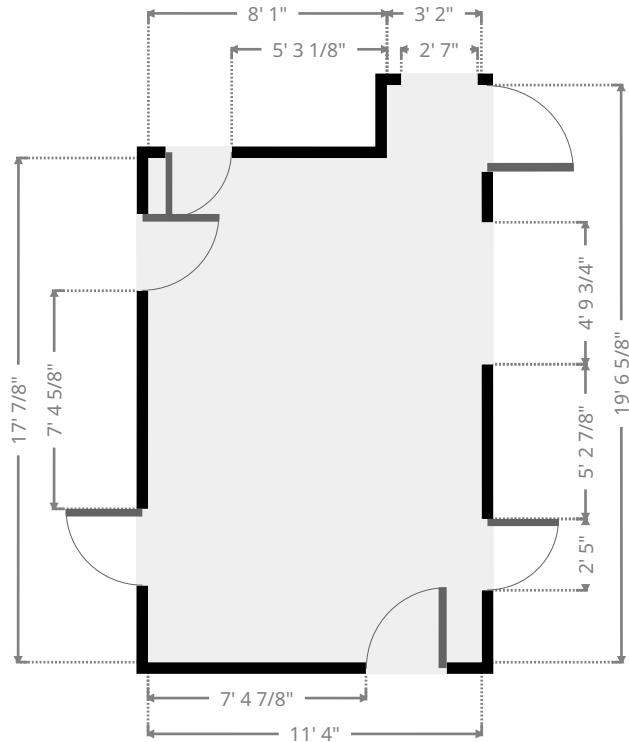
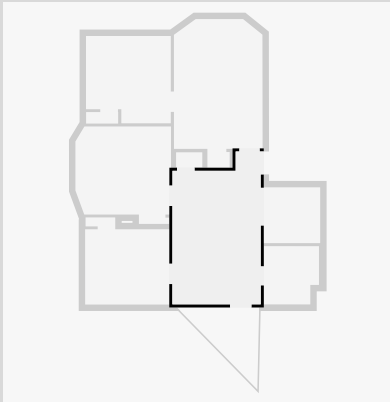

## Balcony

Width: 7' 6 1/4"  
 Length: 14' 8 1/2"  
 Area: 55.32 sq ft  
 Perimeter: 35' 8 7/8"

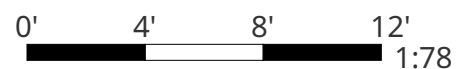
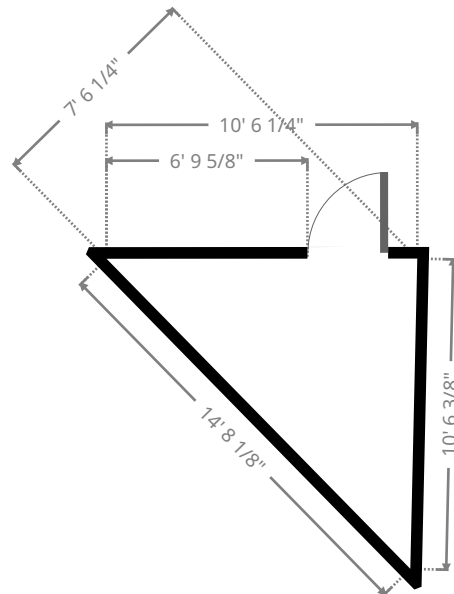
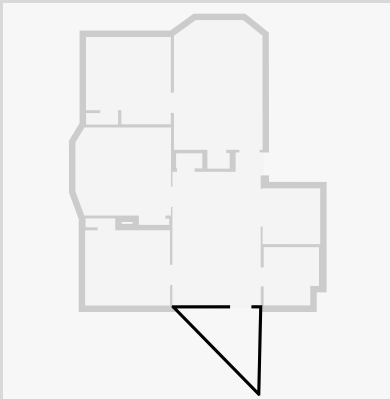

THIS FLOORPLAN IS PROVIDED WITHOUT WARRANTY OF ANY KIND. SENSOPIA DISCLAIMS ANY WARRANTY INCLUDING, WITHOUT LIMITATION, SATISFACTORY QUALITY OR ACCURACY OF DIMENSIONS.

# Gresley #20 and 21

## Bedroom

Width: 11' 3 1/8"  
 Length: 12' 2 5/8"  
 Area: 134.67 sq ft  
 Perimeter: 45' 2 1/4"

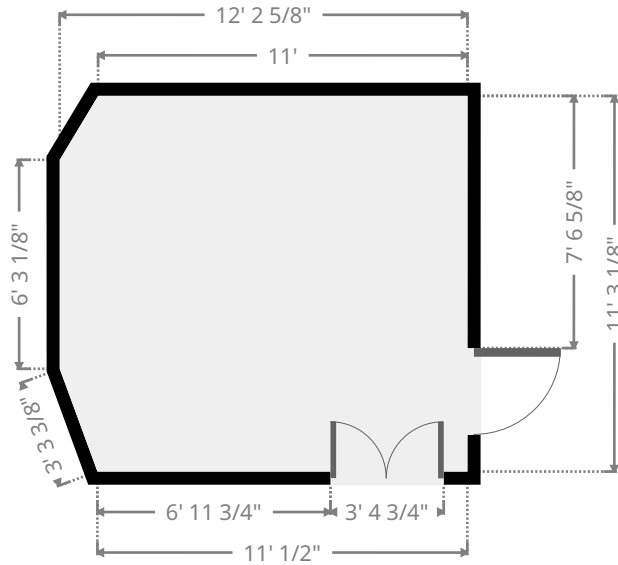
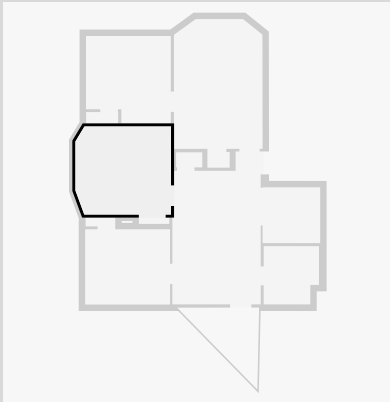

## Living Room

Width: 11' 4"  
 Length: 16' 7 1/8"  
 Area: 182.59 sq ft  
 Perimeter: 53' 2 1/8"

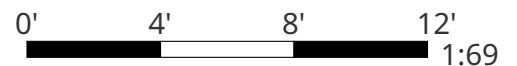
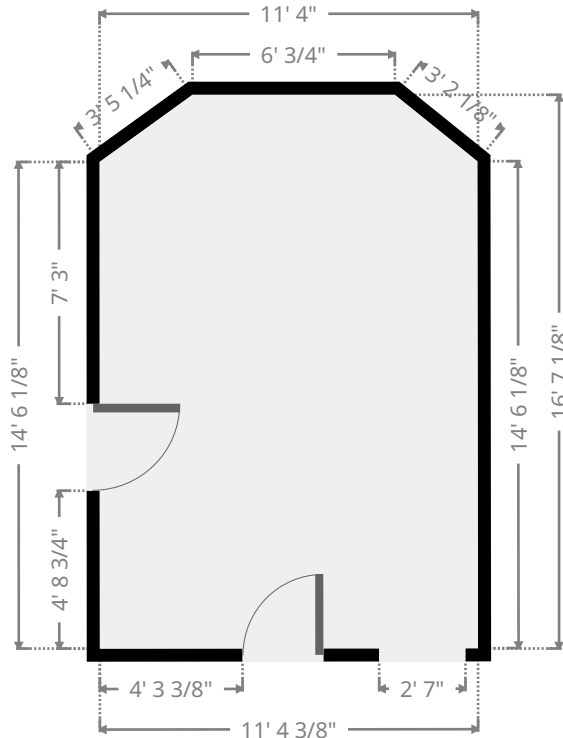
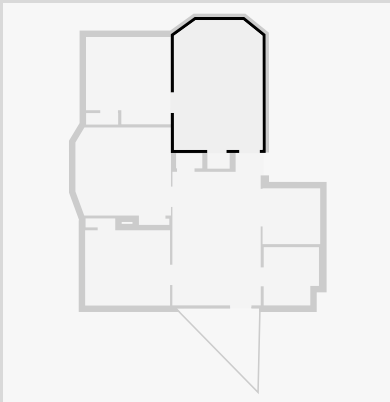

THIS FLOORPLAN IS PROVIDED WITHOUT WARRANTY OF ANY KIND. SENSOPIA DISCLAIMS ANY WARRANTY INCLUDING, WITHOUT LIMITATION, SATISFACTORY QUALITY OR ACCURACY OF DIMENSIONS.

# Gresley #20 and 21

## Closet

Width: 2'  
 Length: 2' 10 1/4"  
 Area: 5.70 sq ft  
 Perimeter: 9' 8 3/8"

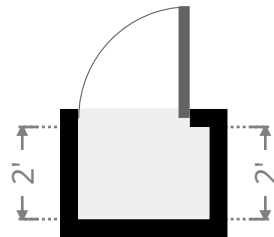
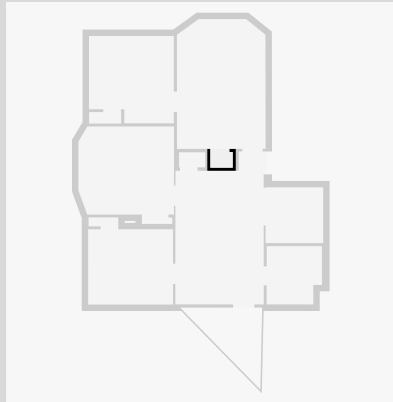

## Bedroom

Width: 10' 10"  
 Length: 11' 2"  
 Area: 112.83 sq ft  
 Perimeter: 43' 11 7/8"

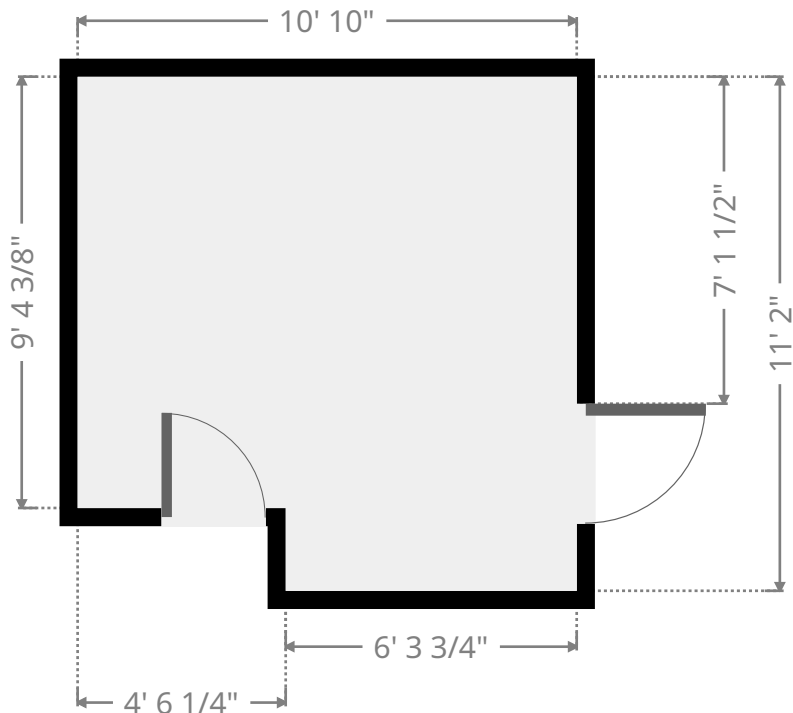
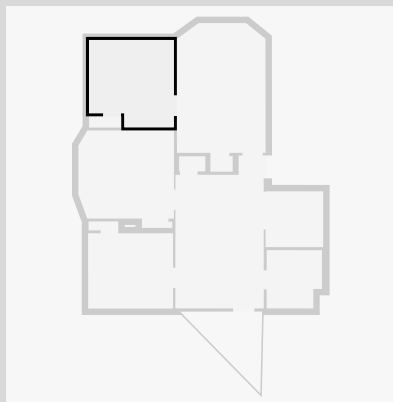

THIS FLOORPLAN IS PROVIDED WITHOUT WARRANTY OF ANY KIND. SENSOPIA DISCLAIMS ANY WARRANTY INCLUDING, WITHOUT LIMITATION, SATISFACTORY QUALITY OR ACCURACY OF DIMENSIONS.

# Gresley #20 and 21

## Closet

Width: 1' 5 5/8"  
 Length: 4' 1 1/8"  
 Area: 6.03 sq ft  
 Perimeter: 11' 1 5/8"

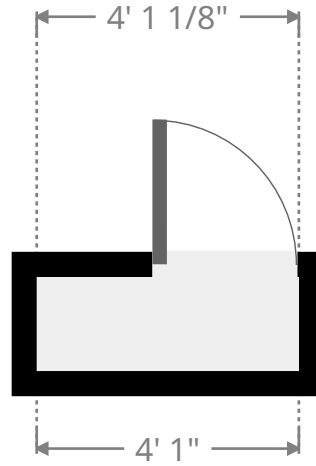
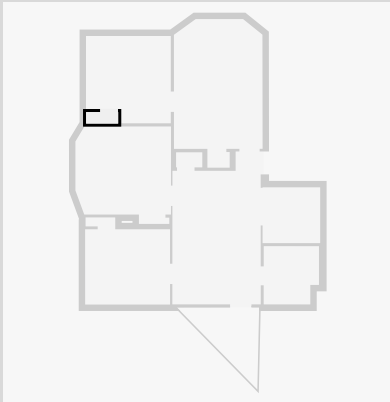

## Bathroom

Width: 7' 3/4"  
 Length: 7' 5 3/8"  
 Area: 49.83 sq ft  
 Perimeter: 29' 1/4"

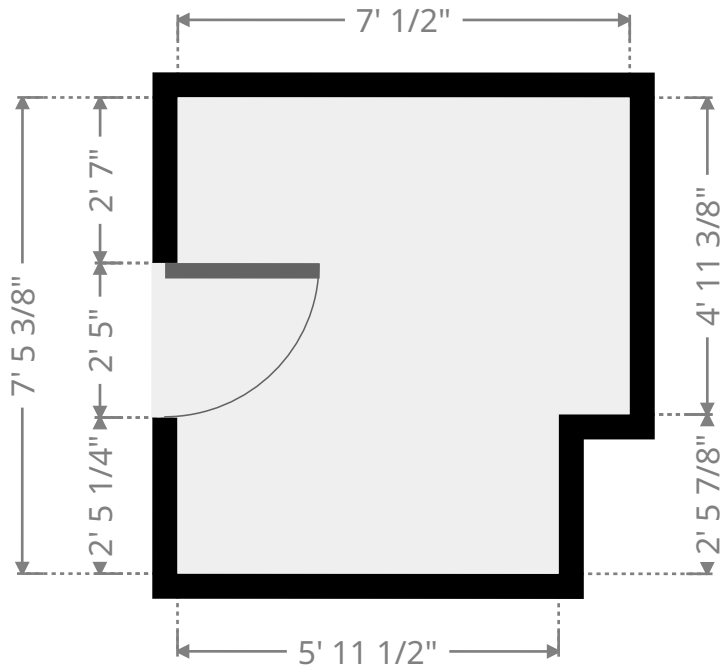
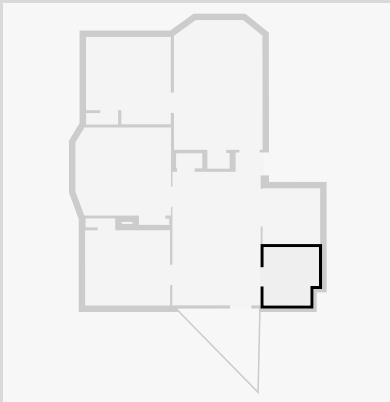

THIS FLOORPLAN IS PROVIDED WITHOUT WARRANTY OF ANY KIND. SENSOPIA DISCLAIMS ANY WARRANTY INCLUDING, WITHOUT LIMITATION, SATISFACTORY QUALITY OR ACCURACY OF DIMENSIONS.

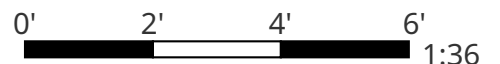

# Gresley #20 and 21

## Bedroom

Width: 9' 7 1/2"  
 Length: 10' 10 1/4"  
 Area: 104.46 sq ft  
 Perimeter: 40' 11 1/2"

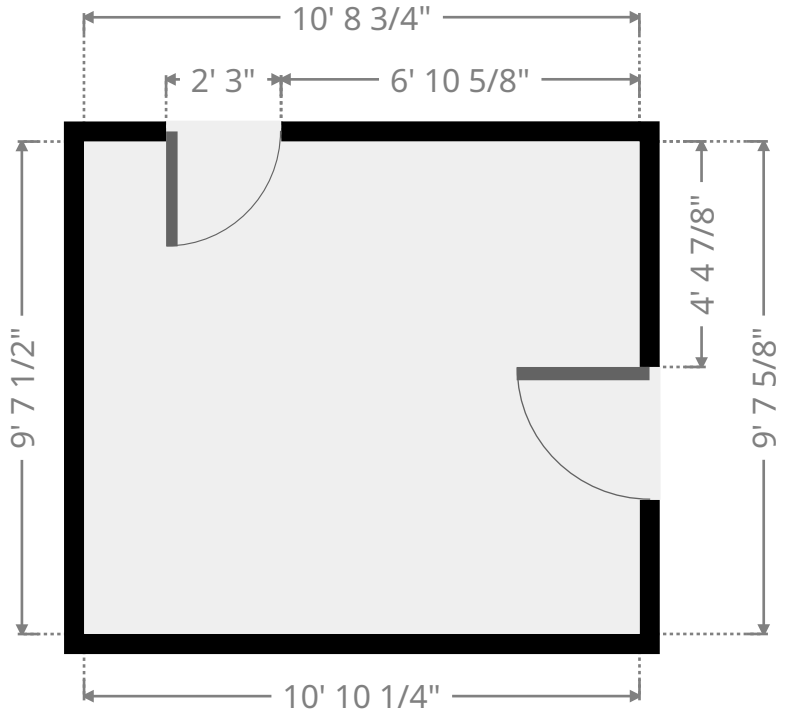
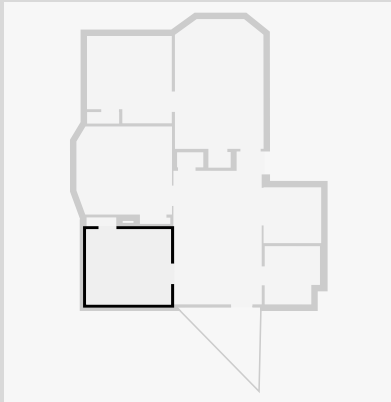

## Closet

Width: 1' 1 3/4"  
 Length: 3' 9 1/2"  
 Area: 4.35 sq ft  
 Perimeter: 9' 10 5/8"

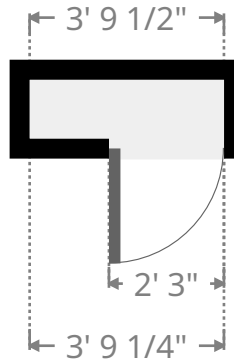
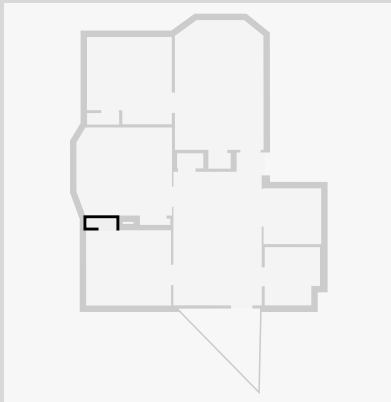

THIS FLOORPLAN IS PROVIDED WITHOUT WARRANTY OF ANY KIND. SENSOPIA DISCLAIMS ANY WARRANTY INCLUDING, WITHOUT LIMITATION, SATISFACTORY QUALITY OR ACCURACY OF DIMENSIONS.



# Gresley #20 and 21

## Kitchen

Width: 7' 1 1/2"  
 Length: 7' 4 3/8"  
 Area: 52.50 sq ft  
 Perimeter: 28' 11 7/8"

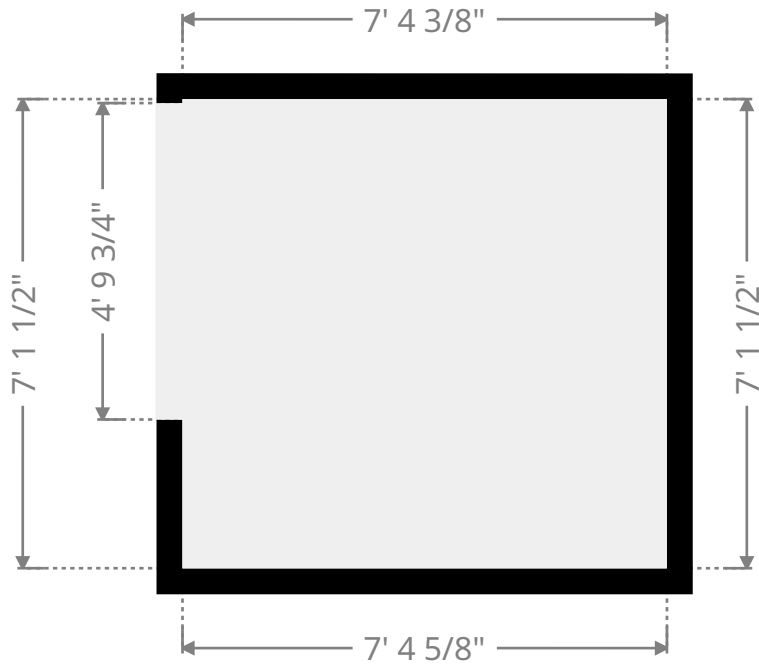
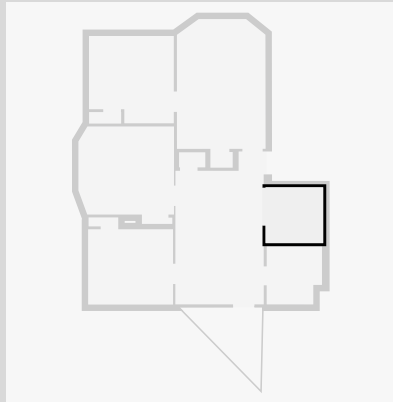

## Closet

Width: 1' 11 1/8"  
 Length: 3' 4 1/4"  
 Area: 6.44 sq ft  
 Perimeter: 10' 6 1/2"

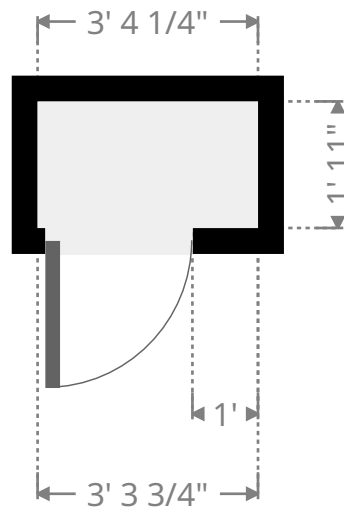
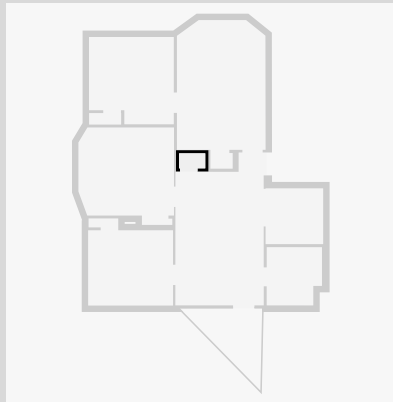

THIS FLOORPLAN IS PROVIDED WITHOUT WARRANTY OF ANY KIND. SENSOPIA DISCLAIMS ANY WARRANTY INCLUDING, WITHOUT LIMITATION, SATISFACTORY QUALITY OR ACCURACY OF DIMENSIONS.

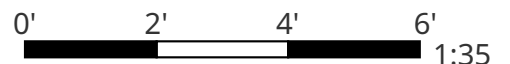

# Gresley #20 and 21

## Closet

Width: 9 5/8"  
Length: 3' 10 5/8"  
Area: 3.10 sq ft  
Perimeter: 9' 4 1/2"

